



Touchscreen Comfort Control



Model TCONT624AS42DA User Guide

Nexia Home Intelligence
Customer Service:
(877) 288-7707

**For HVAC related
issues, contact your
servicing dealer**

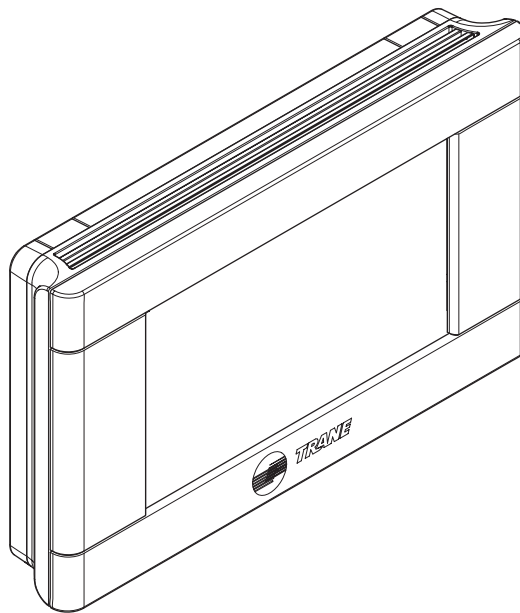

→ NOTE: A 24 Volt common and hot wire **MUST** be connected to the TCONT624A for operation.

Contents

User Guide

Features	2
Operation	3
User Settings	4
Scheduling	5
Enrolling into "Z-Wave" Network (Nexia™ Home Intelligence).....	8
Un-enroll comfort control from existing "Z-Wave" Network (Nexia™ Home Intelligence).....	9
Firmware Upgrades	10
About	11
Clean Screen	11
Limited Warranty	12
FCC/IC Notice.....	14

Features

TCONT624AS42DA Features

- 24v, Z-Wave comfort control
- Remote access via smart phone, tablet, or P.C. (requires SK101 and a Nexia™ Home Intelligence account).
- Interactive 4.3" black & white touchscreen
- 7 Day programmable, 4 schedules/day
- Built in humidity sensor with RH display
- Filter, maintenance, humidifier service reminders
- Remote temperature sensing option (1 indoor/1 outdoor)
- Auxiliary & compressor heat lockouts
- Dehumidification (overcooling)
- Enhanced dehumidification (cooling)
- Adjustable variable speed fan settings (pwm)
- Energy Savings Mode (ESM)
- Screen lock and guest lock
- Upgradable firmware (requires a Nexia™ Home Intelligence account).
- Service test modes
- Humidifier control

User Guide

Operation

The model TCONT624AS42DAA Comfort Control provides typical operation of a forced air heating and cooling HVAC system. The TCONT624 comfort control also features a Z-Wave™ module for remote control.

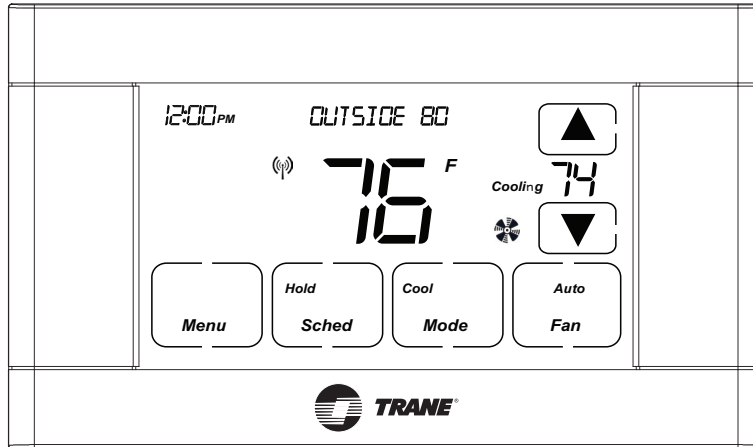

Normally, the Comfort Control displays the Home Screen as shown above.

Item	Description	Notes
Clock Display	The current time is displayed in the upper left corner of the main screen. The time will blink when the clock has not been set.	See TIME/DATE for more information. If the control is connected to Nexia Home Intelligence the clock will be updated by the Nexia portal.
Dynamic Labels and Function Control Buttons	The buttons are defined by the dynamic labels in each button. As you navigate through menus, the labels for the buttons will change.	
Setpoint Display and Setpoint Up/Down Buttons	The current heat or cool setpoint is displayed. These setpoints may be set using Nexia Home Intelligence, the Control's internal schedule, or by pressing the Setpoint Up/Down buttons. Pressing the setpoint button changes the setpoint screen. The current mode is displayed at the top of the screen. Adjust the setpoint by pressing the up or down arrows. To change setpoint mode press the MODE button.	The setpoints will push each other if they are adjusted to within the minimum heat/cool separation setting. This is normally 3 degrees.
Temperature Display	The Comfort Control displays the current temperature as sensed by the internal temperature sensor.	The internal temperature sensor can be adjusted as necessary.
Menu Button	Button used to access other Comfort Control menus	Other Comfort Control menus can be accessed by pressing the MENU button.
System Mode Button	Button used to change the system mode	Off: System off Heating: Heating only Cooling: Cooling only Auto: Heating/Cooling as necessary EM Heat: Indoor Heat only
Fan Mode Button	Button used to change the fan mode:	Auto: Fan on when cooling/heating is necessary On: Fan constantly on Circ: Fan on for a user-selected number of minutes per hour.
Schedule Mode Button	Button used to change the schedule mode:	Hold: System maintains the current temperature setpoints. Schedules are disregarded. Run: Run the system schedule Energy Saving Mode (ESM): Temperature setpoints in ESM Setpoints are maintained.

User Guide

User Settings

User Settings allow the user to customize various settings on the 624 control. To access User Settings simply press the Menu button once and “User Settings” will be displayed. To enter the User Settings menu, press the Select button, then use the Next button to navigate through the options below. The default setting will be shown in brackets. After each selection press the Done button to save changes.

Thermostat		
Setting	Range	Description
Temperature Scale	[Fahrenheit], Celsius	Select the temperature display scale
Cooling RH Setpoint	30% - 60% [50%]	Select the desired indoor relative humidity during cooling mode. Dehumidification must be enabled in the Installer Settings for this option to be available.
Heating RH Setpoint	10% - 45% [40%]	Select the desired indoor relative humidity during heating mode. Humidification must be enabled in the Installer Settings for this option to be available.
Smart Continuous Fan	Yes, [No]	If yes is selected, continuous fan mode is disabled when indoor humidity exceeds the Cooling RH Setpoint
Continuous Fan Airflow	35% - 100% [50%]	Select the desired fan speed when the Fan Mode selected is Continuous (variable speed blower required)
Fan Circulate On Time	1 - 59 minutes, [Off]	Select the desired amount of time the fan will cycle per hour when the Fan Mode selected is Circ
Local Schedule Enable	[Yes], No	Select whether scheduling will be enabled or disabled
Max Heat Setpoint	55 - [90] Degrees	Select the highest heating setpoint allowed
Min Cooling Setpoint	[60] - 99 Degrees	Select the lowest cooling setpoint allowed
H/C Delta	[3] - 15 Degrees	Select the minimum deadband between Heating and Cooling setpoints
Once all selections have been made, press the Done button to exit and return to Menu. Press Next to navigate to the next setting.		
Energy Savings Mode		
Setting	Range	Description
ESM Heat Setpoint	55 - 90 degrees [62]	Select the desired Heating Setpoint when ESM (Energy Savings Mode) is selected
ESM Cooling Setpoint	60 - 99 Degrees [85]	Select the desired Cooling Setpoint when ESM (Energy Savings Mode) is selected
Once all selections have been made, press the Done button to exit and return to Menu. Press Next to navigate to the next setting.		
Display		
Setting	Range	Description
Screen Timeout	[0] - 90 Seconds	Select how long after the last button press before the screen timeouts to a minimized screen
Backlight Timeout	0 - 90 Seconds [20]	Select how long after the last button press before the backlight dims
Backlight On Percent	0 - [100] Percent	Select the screen brightness when the backlight is lit
Backlight Off Percent	[0] - 100 Percent	Select the screen brightness when the backlight timeout expires
Buzzer Enable	[Yes], No	Select whether button presses are audible
Security	[Unlocked], Display Lock, Guest Access	Select security level <ul style="list-style-type: none"> • Unlocked - Enables selection of all menus and settings • Display Lock - Disables selection of all menus and settings • Guest Access - Disables selection of all menus and settings except the following: Raise or lower heating or cooling setpoint +/- 5 degrees and change system mode Note: When Display Lock or Guest Lock is selected a lock icon will appear next to the up arrow. Note: To disable Display Lock or Guest Access, press and hold the up and down arrows until the lock icon disappears.
Once all selections have been made, press the Done button to exit and return to Menu. Press Next to navigate to the next setting.		

User Guide

User Settings Continued

User Settings allow the user to customize various settings on the 624 control. To access User Settings simply press the Menu button once and “User Settings” will be displayed. To enter the User Settings menu, press the Select button, then use the Next button to navigate through the options below. The default setting will be shown in brackets. After each selection press the Done button to save changes.

Time/Date		
Setting	Range	Description
Hour	1 - 12 am, 1 - 12 pm	Select the current hour of day
Minutes	0 - 59	Select current minute of day
Day of Week	Sun - Sat	Select current day of week
Year	2013 - 2113	Select current year
Month	Jan - Dec	Select current month of year
Date	1 - 31	Select current day of month
Once all selections have been made, press the Done button to exit and return to Menu. Press Next to navigate to the next setting.		
Reminders		
Setting	Range	Description
Filtration Enable	Yes, [No]	Selecting yes, enables the Filter Reminder feature
Filter Period	[Monthly], Quarterly, Semi-Annually, Annually	Select how often the reminder will be displayed
Filter Start Month	[Jan] - Dec	Select the Filter Reminder start month
System Maint Enable	Yes, [No]	Selecting yes, enables the System Maintenance Reminder feature
First Maint Month	Jan - Dec	Select the first System Maintenance month
Second Maint Month	Jan - Dec	Select the second System Maintenance month
Once all selections have been made, press the Done button to exit and return to Menu. Press Next to navigate to the next setting.		

Scheduling

Schedule Setup Procedure

The 624 comfort control is preset at the factory with a 7 Day energy savings schedule. Each day of the week is pre-programmed with the following schedule:

Scheduling			
Time	Schedule Name	Heat Temperature Setting	Cool Temperature Setting
6:00 AM	Wake	70 F	78 F
8:00 AM	Day	62 F	85 F
6:00 PM	Evening	70 F	78 F
10:00 PM	Night	62 F	78 F
The schedule may be changed locally at the control with the Edit Schedule menu. If the 624 comfort control is connected to Nexia Home Intelligence the schedule may be changed remotely from the Nexia website using the website's Edit Schedule menu.			

User Guide

Scheduling

Edit Schedule (Local)

Press the following button sequence to edit or create an entirely new daily schedule.

Edit Schedule		
Button Press	Menu Displayed	What Needs to Be Done?
Press Menu from Home screen	USER SETTINGS	
Press Next	SCHEDULE	
Press Select	EDIT SCHEDULE	
Press Select	SELECT DAY	Continue to press "Next" until the day of week to edit is displayed.
Press Select	SET TIME	Set the start time for each of four periods for the day displayed. Use the Up/Down buttons to set the start time for the period displayed. Wake is the default period. Pressing the "Next" button three times cycles through the period displayed (Wake, Day, Evening and Night).
Press Next	HEAT SETPOINT	Use the Up/Down arrows to set the Heat set point for the period displayed
Press Next	COOL SETPOINT	Use the Up/Down arrows to set the Heat set point for the period displayed
Press Next		Continue pressing Next and using up/down arrows until all Heat & Cool set points are set for the day displayed. After editing a start time or editing the set point temperature for one or more periods press "Done" to save edits. If "Done" is not pressed edits will not be saved.
After Pressing Done	Copy Schedule is displayed at the top of the screen. Yes and No buttons are displayed on the right side of the screen.	Press <u>yes to copy</u> or <u>no to return to Edit Schedule menu.</u>
Press Yes to Copy	COPY "___" To ___ is displayed at the top of the screen. Yes and No buttons are displayed on the right side of the screen.	Pressing Yes will copy the day displayed to the next day in the week. If Yes is pressed five more times the scheduled will be copied to the remaining 5 days in the week. To skip over a day and avoid copying the schedule to that day press No.
Press Done	EDIT SCHEDULE menu is displayed	To return to the Home Screen press "Done" one more time.
Press Done	Home Screen is displayed	

The schedule may be changed locally at the control with the Edit Schedule menu. If the 624 comfort control is connected to Nexia Home Intelligence the schedule may be changed remotely from the Nexia website using the websites Edit Schedule menu.

User Guide

Scheduling

Copying Schedules

Press the following button sequence to access “Copying Schedules” from the Home Screen.

Copying Schedules		
Button Press	Menu Displayed	What Needs to Be Done?
Menu		
Next	USER SETTINGS screen	
Select	EDIT SCHEDULE screen	
Next	COPY SCHEDULE screen	
Select	COPY FROM screen (Mon)	Defaults to Monday
Next		Advances to next day
Back		Goes back to previous day
Select	Copy To screen	Select the day to copy to by pressing on Yes or No buttons until the copy to day is selected.
Press Done	COPY SCHEDULE	Continue copying one days schedule at a time to another or Press Done until the Home Screen Appears
Press Done	SCHEDULE	
Press Done	HOME SCREEN is displayed	
Press Done	Home Screen is displayed	

The schedule may be changed locally at the control with the Edit Schedule menu. If the 624 comfort control is connected to Nexia Home Intelligence the schedule may be changed remotely from the Nexia website using the websites Edit Schedule menu.

Edit Schedule (Remotely) - from Nexia Home Intelligence

Go to MyNexia.com, log into your account and select a TCONT624 comfort control from the Climate Page. Click on Edit Schedule and follow the online instructions. If you have not set up a Nexia Home Intelligence account go to MyNexia.com and click on “Get Started” to set up an account. A router and Nexia Bridge kit (SK101 - includes one Nexia Bridge and one Z-wave module) is required for remote access to the 624 control. For questions about connecting to Nexia Home Intelligence contact Nexia Home Intelligence Customer Service at 877-288-7707

Enroll Comfort Control into existing Z-Wave Network (Nexia™ Home Intelligence)

1 Prepare the bridge for enrollment. (Bridge kit SK101 purchased separately)

- Note: If the bridge is already installed, follow the instructions as they are written in the following steps. If the bridge is not installed, follow the instructions shipped with the bridge kit.
- a. Unplug Ethernet and power cables from bridge.
- b. Install a quality 9 volt battery.
- c. Verify that blue light is blinking. If blue light is solid, battery is dead.
- d. Take bridge to the location where the Comfort Control is mounted.

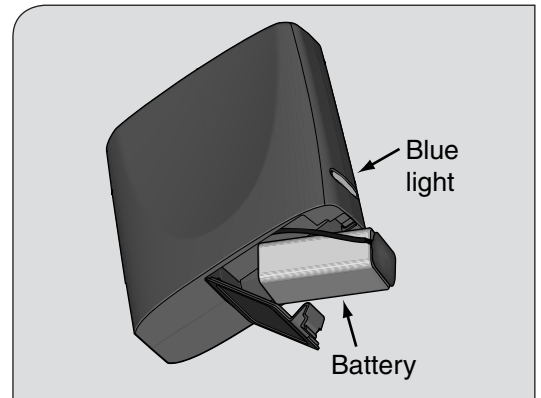

2 Enroll the Comfort Control into the bridge. (Inclusion)

If you are using a controller that is not a Nexia™ bridge, consult the instructions that shipped with the controller to find out how to enroll a new device.

- a. Hold the bridge within 6 feet (1.8 meters) of the Comfort Control throughout steps “b” through “f”.
 - After you begin the enrollment process, you have 30 seconds to complete the remainder of the steps. Study the steps below before beginning.
- b. Press and release the plus (+) button on the bridge.
- c. Press the MENU button on the Comfort Control.
- d. Press the NEXT button to advance to the Z-WAVE menu.
- e. Press SELECT
- f. Observe the lights on the bridge. The orange light will blink while enrollment is taking place. Enrollment is complete when the orange light becomes solid.

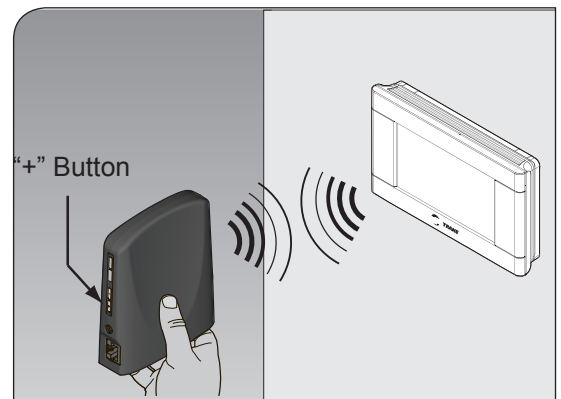

3 Verify enrollment of the Comfort Control.

- a. Press Menu Button on the main Comfort Control screen.
- b. Press the Next Button to advance to the About screen and press the Select Button.
- c. Press the Next Button to advance through the menu options to Node ID
 - If the number listed there is anything other than “00”, the Comfort Control has been successfully enrolled.
 - If the number listed there is “00”, the Comfort Control has NOT been successfully enrolled. In this case, repeat step 18 and verify again.
- d. Press Done button 2 times when finished.

Item	Description
VERSION 010000	Firmware version (number may vary)
ZWAVE VER 034006	Z-Wave version (number may vary)
NODE-ID 01	Z-Wave node ID (number may vary)
HOME-ID 00000000	Z-Wave Home ID (number may vary)
OUT-TYPE AC	Outdoor type may be AC, HP or NONE
C/O WITH COOL	Energize Reversing Valve with COOL or with HEAT (HP only)
IN-TYPE GAS/OIL	Indoor type may be GAS/OIL, ELECTRIC or HYDRONIC

Enroll Comfort Control into existing Z-Wave Network (Nexia™ Home Intelligence) Continued

4 Establish Online Connection to the Comfort Control.

Nexia Home Intelligence account must be active before continuing. See nexiahome.com for more information.

- a. Remove the battery from the bridge.
- b. Plug the Ethernet and power cord back into the bridge.
- c. Log into your account at www.mynexia.com
- d. Click the Climate tab and follow the on screen instructions.

Note: If the new thermostat icon remains gray or cannot be controlled remotely, you might need to add Z-wave repeaters to improve communications. Contact your local Nexia expert or call 877-288-7707 for assistance.

Un-enroll Comfort Control from existing Z-Wave Network (Nexia™ Home Intelligence)

1 If you need to remove the 624 from a Nexia Home Intelligence account, follow the Exclusion steps. This will delete the ability to control the thermostat remotely. If you are unsure, please contact Nexia support at 877-288-7707.

Install a new, high-quality 9-volt battery into the bridge.

- a. Hold the bridge within 6 feet (1.8 meters) of the Comfort Control throughout the entire exclusion process.
 - ➔ After you begin the exclusion process, you have 30 seconds to complete the remainder of the steps. Study the steps below before beginning.
- b. Press and release the minus (-) button on the bridge.
- c. Press the **MENU** button on the Comfort Control.
- d. Press NEXT button to scroll to Z-WAVE screen then press SELECT.
- e. Press the **Yes** button to exclude the Comfort Control.
- f. Observe the lights on the bridge. The orange light will blink while exclusion is taking place. Exclusion is complete when the orange light becomes solid.
 - ➔ Z-Wave™ controllers from various manufacturers may support the Z-Wave™ Thermostat General V2 Device class used by the Z-Wave™ Comfort Control. If you are using a controller that is not a Nexia bridge, consult the instructions that came with the controller to find out how to enroll a new device.

Firmware Upgrades

1

Firmware Upgrades allow the user to update the 624 control. Upgrades may take up to 45 minutes. The system operation will be maintained during the upgrade process. To access the Firmware Upgrades navigate to mynexia.com and look for the Edit Home screen button. The Edit Home screen button is located about mid way own the Nexia Home Page.



- a. On the Edit Home, Firmware Updates page, the 624 will appear. If a firmware update is available an "Update Firmware" button will appear.

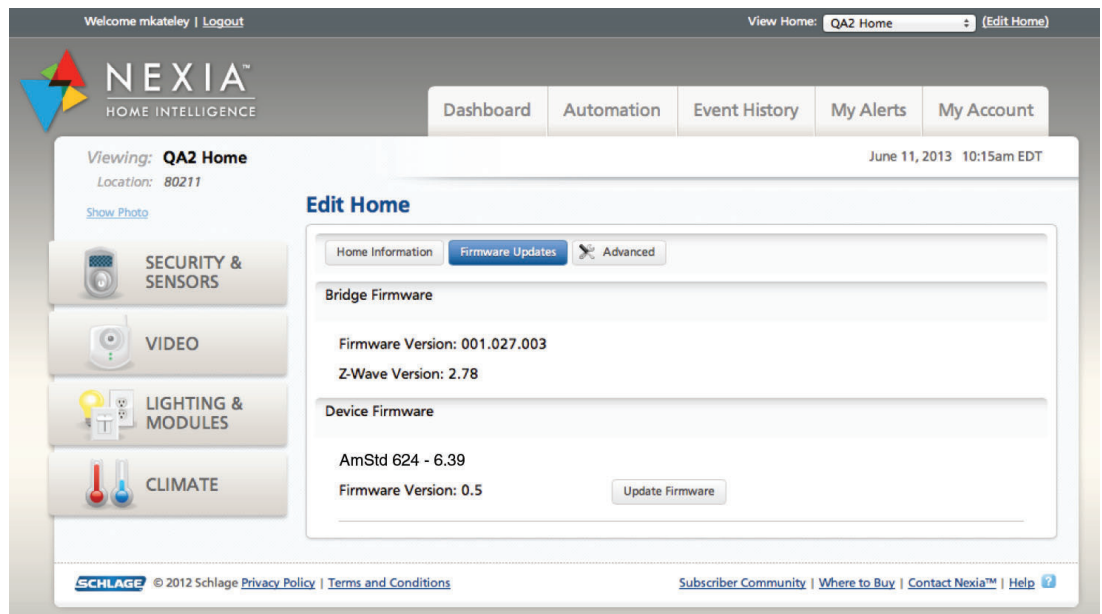

User Guide

- b. When the user selects the “Update Firmware” button an “Update Firmware” dialog will appear. The dialog will first connect to the device and then it will display the firmware update progress.

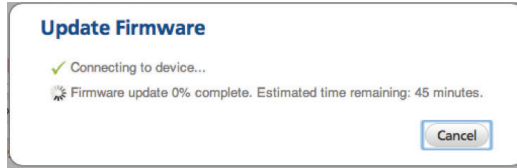

- c. After the firmware has been downloaded it is then applied to the TCONT624.

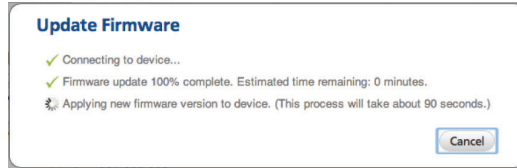

- d. The portal retrieves version information from the TCONT624.

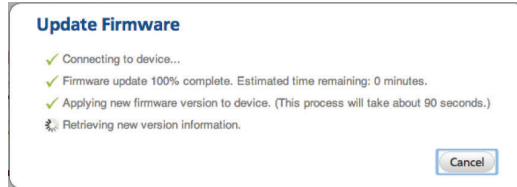

- e. Finally the user is shown that the firmware was updated successfully



About

About	
Setting	Range
Version	Current firmware version loaded on the control
ZWAVE Ver	Current version of the ZWAVE firmware
Node - ID	ZWAVE identification for this device
Home - ID	ZWAVE identification for the connected ZWAVE network
Out - Type	Identifies the type of outdoor unit installed
C/O - Type	Indicates whether the switchover valve (SOV) is energized in cooling or heating mode
In - Type	Identifies the type of indoor unit installed

Once all selections have been made, press the Done button to exit and return to Menu. Press Next to navigate to the next setting.

Clean Screen

Clean Screen		
Setting	Range	Description
Clean Screen	Yes, No	Selecting yes allows the user to clean the screen without activating any of the onscreen touch points. Use only water and a soft cloth, no harmful chemicals.

Once all selections have been made, press the Done button to exit and return to Menu. Press Next to navigate to the next setting.

Warranty

Base Limited Warranty

Subject to the terms and conditions of this limited warranty, Trane U.S., Inc. ("Company") extends a limited warranty against manufacturing defects for the product(s) identified in **Tables 1, 1A, 1B** attached hereto ("Products") that are installed in a residential/multi-family application (personal, family or household purposes) under normal use and maintenance in the United States and Canada.

This limited warranty applies to Products manufactured on or after August 1, 2011.

In order to maximize the available benefits under this limited warranty, the Purchaser (as defined below) should read it in its entirety. All repairs of Product parts covered under this limited warranty must be made with authorized service parts and by a licensed HVAC service provider. Additionally, commercial applications are treated differently under this limited warranty as stated in **Tables 1, 1A, 1B** attached hereto. For purposes of this limited warranty, "commercial applications" shall mean any application other than for personal, family, or household use.

TERM: The limited warranty period for Products is as stated in **Tables 1, 1A, 1B** attached hereto. If the Purchaser properly registers the Products, the limited warranty period shall be extended as stated in **Tables 1, 1A, 1B** attached hereto. Regardless of registration, the Commencement Date for a limited warranty period shall be the date that the original installation is complete and all Product start-up procedures have been properly completed and verified by an installer's invoice. If the installation and start-up date cannot be verified by the installer's invoice, the Commencement Date shall be sixty (60) days after the factory manufacture date which is verified by the Product serial number. Where a Product is installed in a newly constructed home, the Commencement Date is the date the Purchaser purchased the residence from the builder. Proof of Product purchase, installation, and/or closing date of the residence may be required to confirm the Commencement Date.

The installation of Product replacement parts under this limited warranty shall not extend the original warranty period. The warranty period for any Product part replaced under this limited warranty is the applicable warranty period remaining under the original Product warranty.

WHO IS COVERED: This limited warranty is provided only to the original owner and his or her spouse ("Purchaser") of the residence where the Products are originally installed. This warranty is not transferable except according to terms stated on the applicable website identified below under Registration Requirements. Company has the right to request any and all proof of Product purchase or installation and/or closing date of the residence.

WHAT COMPANY WILL DO: Company may request proof of Product purchase and/or installation in order to provide Product parts under this limited warranty. As Company's only responsibility and Purchaser's only remedy under this limited warranty, Company will furnish a replacement part to the licensed HVAC service provider, without charge for the part only, to replace any Product part that fails due to a manufacturing defect under normal use and maintenance. The Purchaser must pay for any and all shipping and handling charges and other costs of warranty service for the replacement part. If a Product part is not available, Company will, at its option, provide a free suitable substitute part or provide a credit in the amount of the then factory selling price for a new suitable substitute part to be used by the Purchaser towards the retail purchase price of a new Company product. Any new Product purchase shall be at Purchaser's sole cost and expense including, but not limited to, all shipping, removal, and installation costs and expenses.

REGISTRATION REQUIREMENTS: All Products must be properly registered online by the Purchaser within sixty (60) days after the Commencement Date to receive the registered limited warranty terms. To register online, go to:

<http://www.trane.com/Residential/For-Owners/Warranties> or

<http://www.americanstandardair.com/servicesupport/pages/warranty.aspx>

and click "Begin Online Registration." If a Purchaser does not register within this stated time period, the base limited warranty terms shall apply.

ELIGIBILITY REQUIREMENTS: The following items are required in order for the Products to be covered under this limited warranty:

- The Products must be in the same location where they were originally installed.
- The Products must be properly installed, operated, and maintained by a licensed HVAC service provider in accordance with the Product specifications or installation, operation, and maintenance instructions provided by Company with each Product. Failure to conform to such specifications and/or instructions shall void this limited warranty. Company may request written documentation showing the proper preventative maintenance.
- All Product parts replaced by Company under this limited warranty must be given to the servicing provider for return to Company.
- Air handlers, air conditioners, heat pumps, cased or uncased coils and stand-alone furnaces must be part of an Air Conditioning, Heating, and Refrigeration Institute rated and matched system or a specification in a Company provided bulletin or otherwise approved in writing by a Company authorized representative.

EXCLUSIONS: The following are not covered by this limited warranty:

- *Labor costs including, but not limited to, costs for diagnostic calls or the removal and reinstallation of Products and/or Product parts.*
- *Shipping and freight expenses required to ship Product replacement parts.*
- *Failures, defects, or damage (including, but not limited to, any loss of data or property) caused by (1) any third party product, service, or system connected or used in conjunction with the Products; (2) any use that is not designed or intended for the Products; (3) modification, alteration, abuse, misuse, negligence, or accident; (4) improper storage, installation, maintenance, or operation including, but not limited to, operation of electrical equipment at voltages other than the range specified on the Product nameplate; (5) any use in violation of written instructions or specifications provided by Company; (6) any acts of God including, but not limited to, fire, water, storms, lightning, or earthquakes; or any theft or riots; or (7) a corrosive atmosphere or contact with corrosive materials such as, but not limited to, chlorine, fluorine, salt (provided that indoor and outdoor coils will only be covered if a Sea Coast Kit is installed), sulfur, recycled waste water, urine, fertilizers, rust, or other damaging substances or chemicals.*
- *Products purchased direct including, but not limited to, Internet or auction purchases and purchases made on an uninstalled basis.*
- *Cabinets or cabinet pieces that do not affect product performance, air filters, refrigerant, refrigerant line sets, belts, wiring, fuses, surge protection devices, non-factory installed driers, and Product accessories (unless otherwise specified).*
- *Increased utility usage costs.*

REFRIGERANT POLICY: (1) **Manufacturer-Installed Refrigerant:** Beginning on January 1, 2010, R-22 refrigerant will no longer be used as a manufacturer-installed refrigerant as required by federal regulation. All Products with manufacturer-installed refrigerant will include R-410A refrigerant. Any and all expenses or costs associated with replacing Product parts that are not R-410A compatible will not be covered by the terms and conditions of this limited warranty. (2) **Non-Manufacturer installed Refrigerant:** For Products manufactured and sold by the Company without refrigerant, only manufacturer approved and genuine alternate refrigerants shall be used. The use of contaminated, counterfeit, non-genuine, or non-manufacturer approved alternate refrigerant will void this limited warranty. (3) **All Products:** Products include a liquid line filter drier which must be replaced when a compressor replacement is necessary. A suction line filter drier must be added for compressors defined as burnouts and failure to do so will void this warranty. Non-approved refrigerant and/or non-approved refrigerant system additives including, but not limited to dyes will void this limited warranty.

GW-658-2913

Warranty

ADDITIONAL TERMS:

THIS LIMITED WARRANTY AND LIABILITY SET FORTH HEREIN ARE IN LIEU OF ALL OTHER WARRANTIES AND LIABILITIES, WHETHER IN CONTRACT OR IN NEGLIGENCE, EXPRESS OR IMPLIED, IN LAW OR IN FACT. THE IMPLIED WARRANTIES OF MERCHANTABILITY AND FITNESS FOR A PARTICULAR PURPOSE ARE LIMITED TO THE DURATION OF THE APPLICABLE PRODUCT WARRANTY. COMPANY DOES NOT AUTHORIZE ANY PERSON TO CREATE FOR IT ANY OBLIGATION OR LIABILITY IN CONNECTION WITH THE PRODUCTS.

NOTWITHSTANDING ANYTHING IN THIS LIMITED WARRANTY TO THE CONTRARY, COMPANY SHALL NOT BE LIABLE FOR ANY INCIDENTAL, CONSEQUENTIAL, INDIRECT, SPECIAL AND/OR PUNITIVE DAMAGES, WHETHER BASED ON CONTRACT, WARRANTY, TORT (INCLUDING, BUT NOT LIMITED TO, STRICT LIABILITY OR NEGLIGENCE), PATENT INFRINGEMENT, OR OTHERWISE, EVEN IF ADVISED OF THE POSSIBILITY OF SUCH DAMAGES. COMPANY'S MAXIMUM LIABILITY HEREUNDER IS LIMITED TO THE ORIGINAL PURCHASE PRICE OF THE PRODUCTS.

No action arising out of any claimed breach of this limited warranty may be brought by a Purchaser more than one (1) year after the cause of action has arisen.

This limited warranty gives you specific legal rights, and you may also have other rights as otherwise permitted by law. If this Product is considered a consumer product, please be advised that some local laws do not allow limitations on incidental or consequential damages, how long a warranty lasts based on registration, or how long an implied warranty lasts, so that the above limitations may not fully apply. Refer to your local laws for your specific rights under this limited warranty.

Consumer Relations

20 Corporate Woods Dr.

Bridgeton, MO 63044

Or visit our website at www.trane.com or www.americanstandardair.com

Table 1A: Warranty Time Periods for Controls, Zoning Products, Humidifiers, Energy Recovery Ventilators, Air Cleaners and Oil Furnaces (Variable and Non-Variable Speed)

COVERAGE TERMS FOR RESIDENTIAL APPLICATIONS: Pursuant to the Trane U.S., Inc. ("Company") limited warranty terms and conditions, the following Products are covered for the base time periods as stated below ("Base Limited Warranty period"). If registered, the Base Limited Warranty Periods for certain products will be extended as stated below ("Registered Limited Warranty Period").

CONTROLS: *CONT200,*CONT401,*CONT402, *CONT600, *CONT602, *CONT624

Base Limited Warranty Period: one (1) year

Registered Limited Warranty Period: five (5) years

CONTROLS: *ZEMT500,*CONT800,*CONT802,*CONT803, *CONT824, *CONT900, *ZONE940, *ZONE950

Base Limited Warranty Period: five (5) years

Registered Limited Warranty Period: ten (10) years

ZONING PRODUCTS: *ZONE950, *ZONE940, *ZONE930, ZZONEPNLAC52Z, ZZONEEXPAC52Z, ZZSENSAL0400, BAYSEN01ATEMPA, BAY24VRP, ZDAMPRD, ZDAMP5M, ZDAMPBM, ZDAMP5R

Base Limited Warranty Period: five (5) years

Registered Limited Warranty Period: ten (10) years

HUMIDIFIERS: *HUMD200, *HUMD300 & *HUMD500

Base Limited Warranty Period: five (5) years

Registered Limited Warranty Period: ten (10) years

ENERGY RECOVERY VENTILATOR (ERV): *ERVR100, *ERVR200 & *ERVR300

Base Limited Warranty Period: five (5) years

Registered Limited Warranty Period: ten (10) years

AIR CLEANERS: TFD & AFD

Base Limited Warranty Period: five (5) years

Registered Limited Warranty Period: ten (10) years

VARIABLE SPEED OIL FURNACE: *HV-V, *LF-V, *LR-V,*DF-V

Base Limited Warranty Period: Parts- five (5) years, Heat Exchanger - twenty (20) years

Registered Limited Warranty Period: Parts - ten (10) years, Heat Exchanger - Lifetime

FCC Notice

FCC ID WIBTZW012

INFORMATION TO USER

This device complies with Part 15 of the FCC Rules. Operation is subject to the following two conditions: (1) This device may not cause harmful interference, and (2) This device must accept any interference received, including interference that may cause undesired operation.

This equipment has been tested and found to comply with the limits for Class B Digital Device, pursuant to Part 15 of the FCC Rules. These limits are designed to provide reasonable protection against harmful interference in a residential installation. This equipment generates and can radiate radio frequency energy and, if not installed and used in accordance with the instructions, may cause harmful interference to radio communications. However, there is no guarantee that interference will not occur in a particular installation. If this equipment does cause harmful interference to radio or television reception, which can be determined by turning the equipment off and on, the user is encouraged to try to correct the interference by one or more of the following measures.

- Reorient or relocate the receiving antenna
- Increase the separation between the equipment and receiver
- Connect the equipment into an outlet on a circuit different from that to which the receiver is connected
- Consult the dealer or an experienced radio/TV technician for help

Any changes or modifications not expressly approved by the party responsible for compliance could void the user's authority to operate the equipment.

IC Notice

IC 9374A-XR624

This device complies with Industry Canada license-exempt RSS standard(s). Operation is subject to the following two conditions: (1) this device may not cause interference, and (2) this device must accept any interference, including interference that may cause undesired operation of the device.

Le présent appareil est conforme aux CNR d'Industrie Canada applicables aux appareils radio exempts de licence. L'exploitation est autorisée aux deux conditions suivantes : (1) l'appareil ne doit pas produire de brouillage, et (2) l'utilisateur de l'appareil doit accepter tout brouillage radioélectrique subi, même si le brouillage est susceptible d'en compromettre le fonctionnement.



©2013 Trane

Trane
6200 Troup Highway
Tyler, TX 75707
www.trane.com

Literature Order Number	32-5088-03
File number	32-5088-03
Supersedes	32-5088-02
Date	10/13

Trane has a policy of continuous product and product data improvement and it reserves the right to change design and specifications without notice.